

SKiiP 25AC126V1



MiniSKiiP[®] 2

3-phase bridge inverter

SKiiP 25AC126V1

Features

- Fast Trench IGBTs
- Robust and soft freewheeling diodes in CAL technology
- Highly reliable spring contacts for electrical connections
- UL recognised file no. E63532

Typical Applications

- Inverter up to 28 kVA
- Typical motor power 15 kW

Remarks

- V_{CEsat} , V_F = chip level value

| Absolute Maximum Ratings | | $T_s = 25\text{ °C}$, unless otherwise specified | |
|--------------------------|---|---|-------|
| Symbol | Conditions | Values | Units |
| IGBT - Inverter | | | |
| V_{CES} | $T_s = 25\text{ (70) °C}$ $t_p \leq 1\text{ ms}$ | 1200 | V |
| I_C | | 73 (55) | A |
| I_{CRM} | | 100 | A |
| V_{GES} | | ± 20 | V |
| T_j | | - 40 ... + 150 | °C |
| Diode - Inverter | | | |
| I_F | $T_s = 25\text{ (70) °C}$ $t_p \leq 1\text{ ms}$ | 62 (46) | A |
| I_{FRM} | | 100 | A |
| T_j | | - 40 ... + 150 | °C |
| I_{tRMS} | per power terminal (20 A / spring) | 100 | A |
| T_{stg} | $T_{op} \leq T_{stg}$ | - 40 ... + 125 | °C |
| V_{isol} | AC, 1 min. | 2500 | V |

| Characteristics | | $T_s = 25\text{ °C}$, unless otherwise specified | | | |
|---------------------------|---|---|------------|-----------|-------|
| Symbol | Conditions | min. | typ. | max. | Units |
| IGBT - Inverter | | | | | |
| V_{CEsat} | $I_{Cnom} = 50\text{ A}$, $T_j = 25\text{ (125) °C}$ | | 1,7 (2) | 2,1 (2,4) | V |
| $V_{GE(th)}$ | $V_{GE} = V_{CE}$, $I_C = 2\text{ mA}$ | 5 | 5,8 | 6,5 | V |
| $V_{CE(TO)}$ | $T_j = 25\text{ (125) °C}$ | | 1 (0,9) | 1,2 (1,1) | V |
| r_T | $T_j = 25\text{ (125) °C}$ | | 14 (22) | 18 (26) | mΩ |
| C_{ies} | $V_{CE} = 25\text{ V}$, $V_{GE} = 0\text{ V}$, $f = 1\text{ MHz}$ | | 3,7 | | nF |
| C_{oes} | $V_{CE} = 25\text{ V}$, $V_{GE} = 0\text{ V}$, $f = 1\text{ MHz}$ | | 0,8 | | nF |
| C_{res} | $V_{CE} = 25\text{ V}$, $V_{GE} = 0\text{ V}$, $f = 1\text{ MHz}$ | | 0,7 | | nF |
| $R_{th(j-s)}$ | per IGBT | | 0,55 | | K/W |
| $t_{d(on)}$ | under following conditions | | 85 | | ns |
| t_r | $V_{CC} = 600\text{ V}$, $V_{GE} = \pm 15\text{ V}$ | | 30 | | ns |
| $t_{d(off)}$ | $I_{Cnom} = 50\text{ A}$, $T_j = 125\text{ °C}$ | | 440 | | ns |
| t_f | $R_{Gon} = R_{Goff} = 12\text{ Ω}$ | | 90 | | ns |
| E_{on} | inductive load | | 5,8 | | mJ |
| E_{off} | | | 6,5 | | mJ |
| Diode - Inverter | | | | | |
| $V_F = V_{EC}$ | $I_{Fnom} = 50\text{ A}$, $T_j = 25\text{ (125) °C}$ | | 1,6 (1,6) | 1,8 (1,8) | V |
| $V_{(TO)}$ | $T_j = 25\text{ (125) °C}$ | | 1 (0,8) | 1,1 (0,9) | V |
| r_T | $T_j = 25\text{ (125) °C}$ | | 12 (16) | 14 (18) | mΩ |
| $R_{th(j-s)}$ | per diode | | 1 | | K/W |
| I_{RRM} | under following conditions | | 71 | | A |
| Q_{rr} | $I_{Fnom} = 50\text{ A}$, $V_R = 600\text{ V}$ | | 11,5 | | μC |
| E_{rr} | $V_{GE} = 0\text{ V}$, $T_j = 125\text{ °C}$ $di_F/dt = 1900\text{ A/μs}$ | | 5,1 | | mJ |
| Temperature Sensor | | | | | |
| R_{ts} | 3 %, $T_r = 25\text{ (100) °C}$ | | 1000(1670) | | Ω |
| Mechanical Data | | | | | |
| m | | | 65 | | g |
| M_s | Mounting torque | 2 | | 2,5 | Nm |

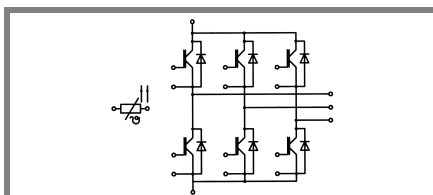

AC

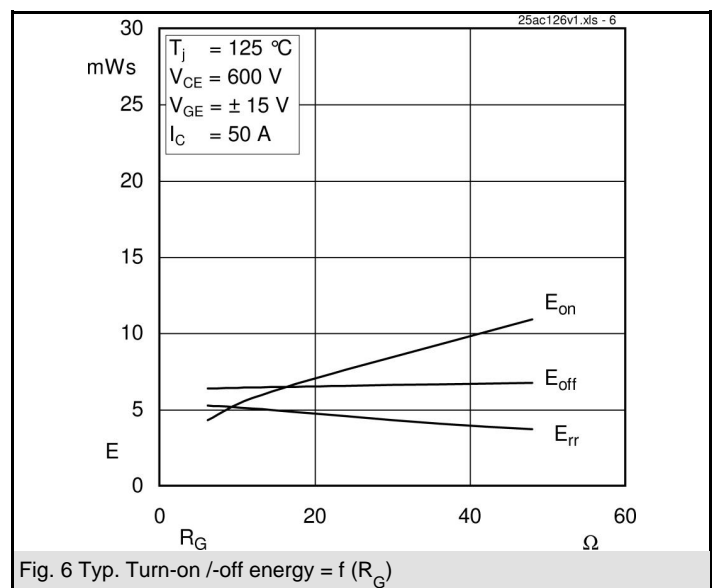
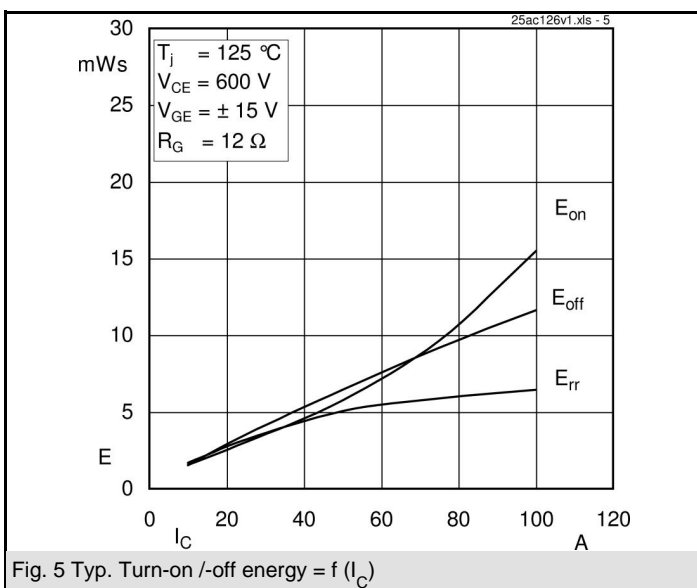
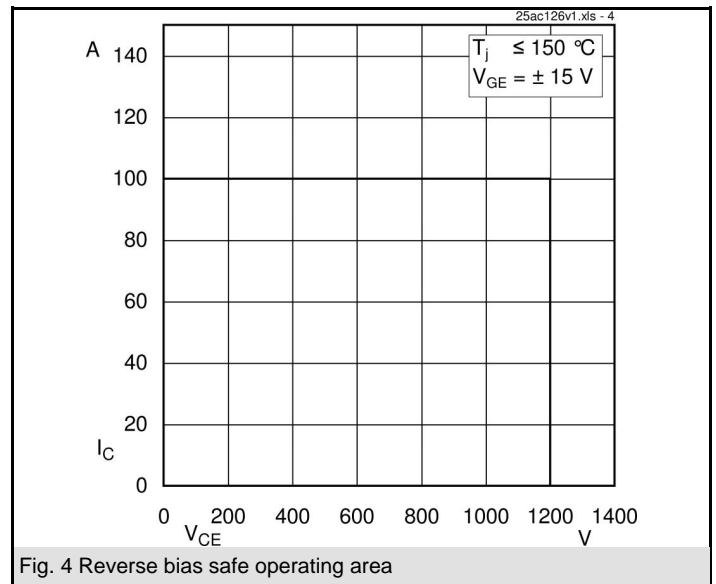
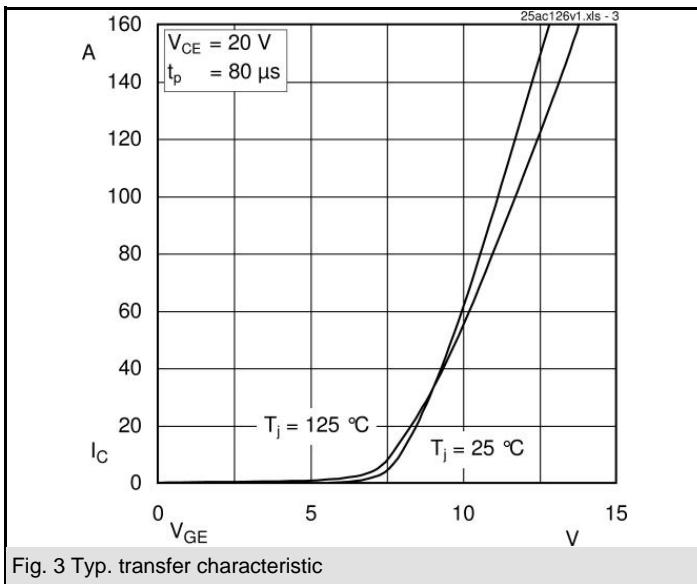
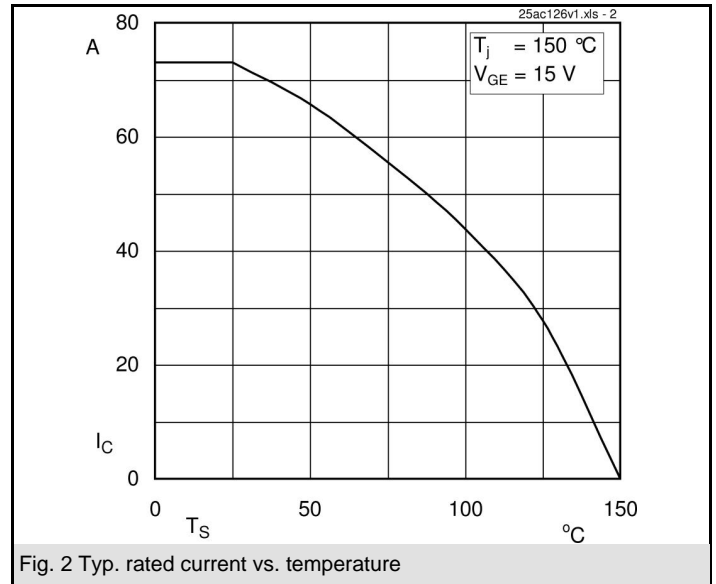
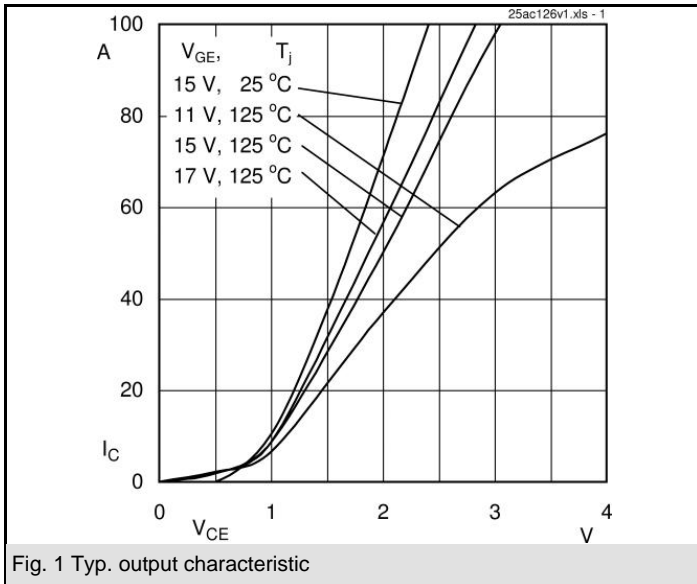

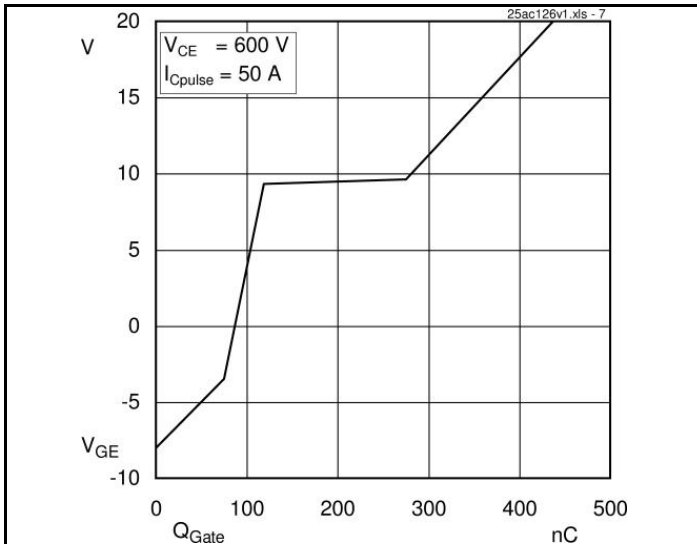

Fig. 7 Typ. gate charge characteristic

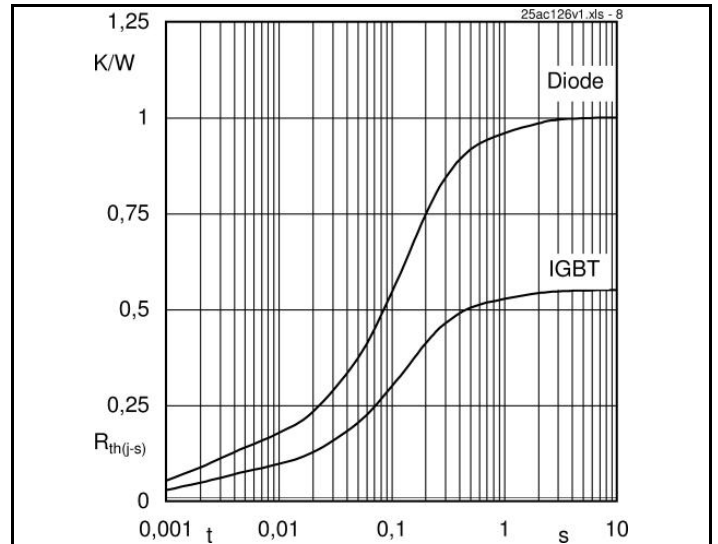

Fig. 8 Typ. thermal impedance

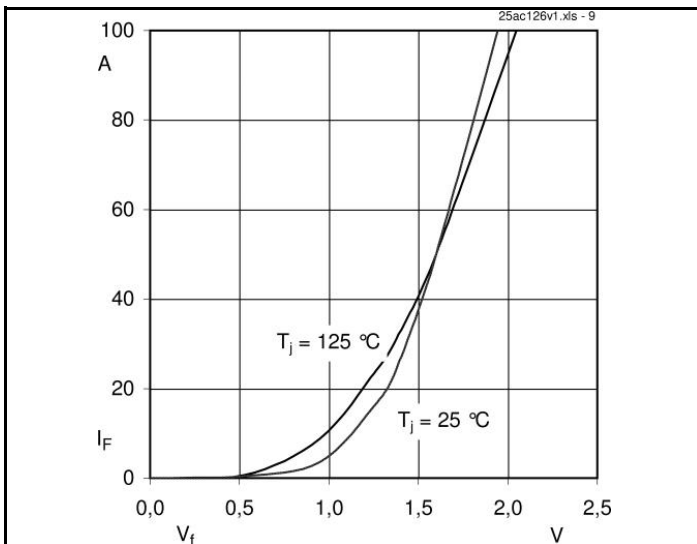
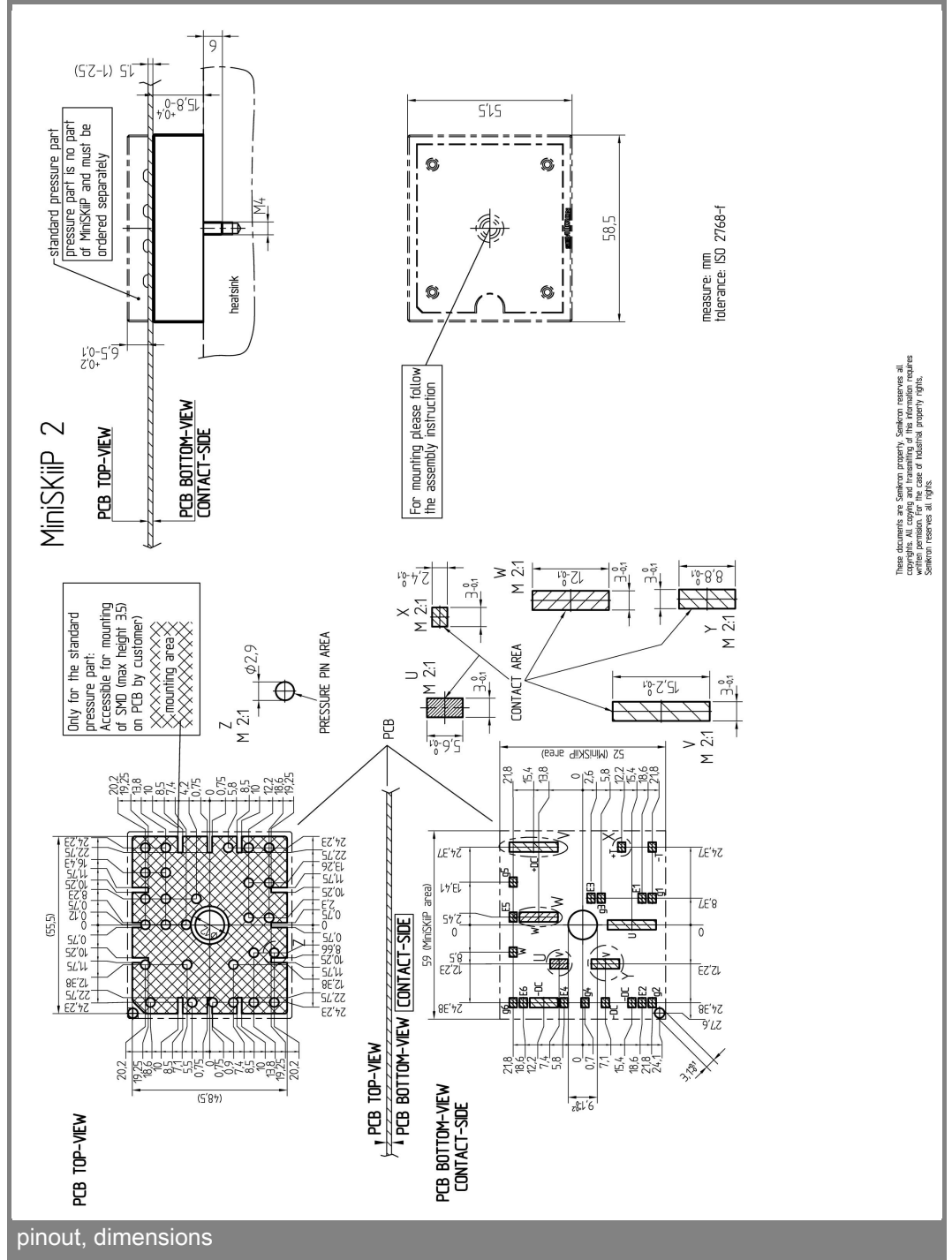
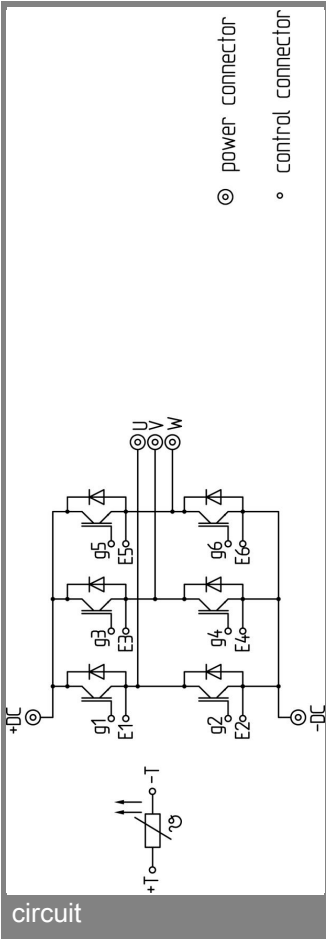

Fig. 9 Typ. freewheeling diode forward characteristic



These documents are Semikron property. Semikron reserves all copyrights. All copies and transmitting of the information requires written permission. In the case of industrial property rights, Semikron reserves all rights.

This is an electrostatic discharge sensitive device (ESDS), international standard IEC 60747-1, Chapter IX.

This technical information specifies semiconductor devices but promises no characteristics. No warranty or guarantee expressed or implied is made regarding delivery, performance or suitability.